

# ECO VALVE

For space saving and weight saving of piping systems.

BS series

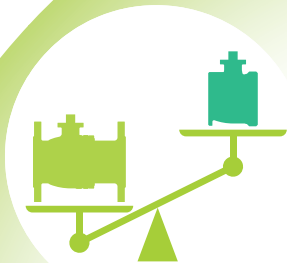

Lightweight

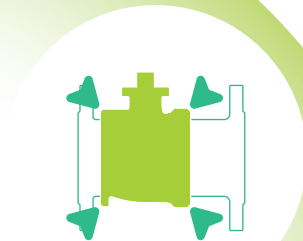

Compact

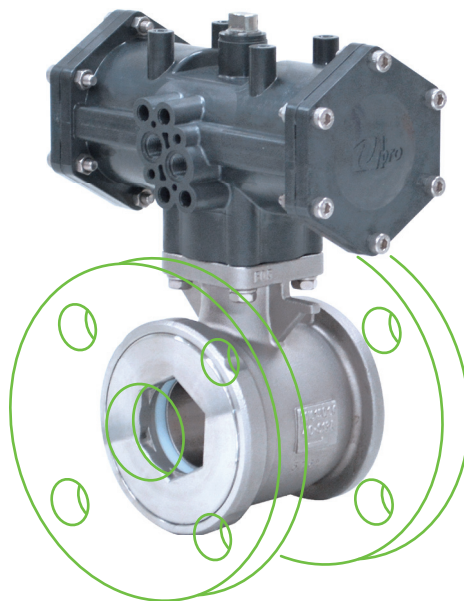

Economical



Conservation  
of  
resources



## Space-saving & maintenance-free design

### Compact and lightweight

By adopting a wafer type valve body, a compact and significant weight reduction has been achieved while maintaining a full-port design with little pressure loss.

<Flange model 50A>

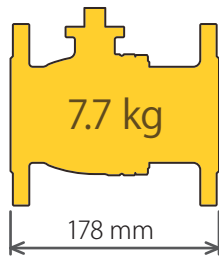

<BS series 50A>



### Maintenance free

The stem spring automatically compensates for wear, pressure and temperature changes in the stem packing for long life. Maintenance free, no need for retightening.

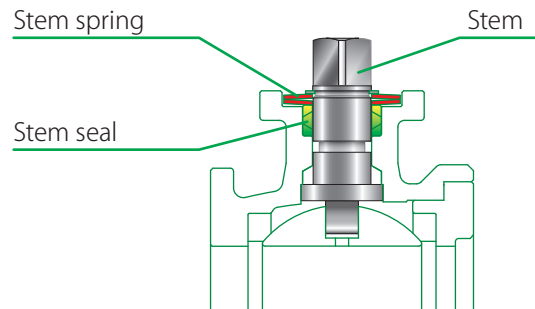

### Support for multiple connectivity standards

The wafer body can be connected to DIN and ANSI flanges as well as JIS 10K flanges.

## Selectable mounting position of manual lever

### You can change the direction of the lever.

The lever position can be changed by removing one bolt. Of course, it can also be removed.

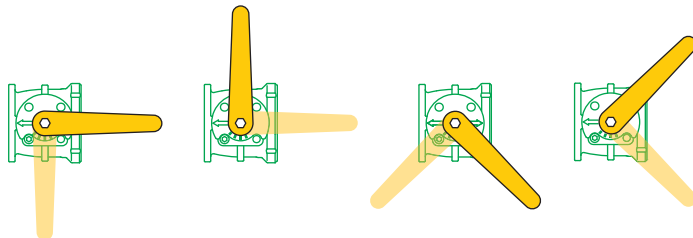

### Easy-to-read opening indicator

An independent opening plate allows you to check valve opening regardless of lever position.

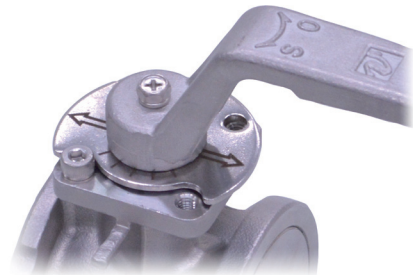

## Wide variety of actuator

Various types of manual, motorized and pneumatic operations are available.



MAX 型



PND 型



AM/AH/DM 型

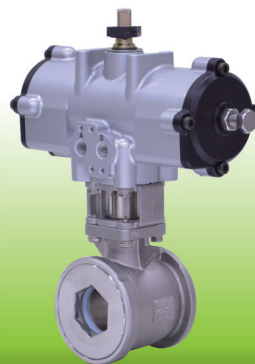

TA 型



AE 型